

Sennheiser HD 800 "Anaxilus Mod" template.
For non-commercial only. Copyright 2012 Source Interlink Media

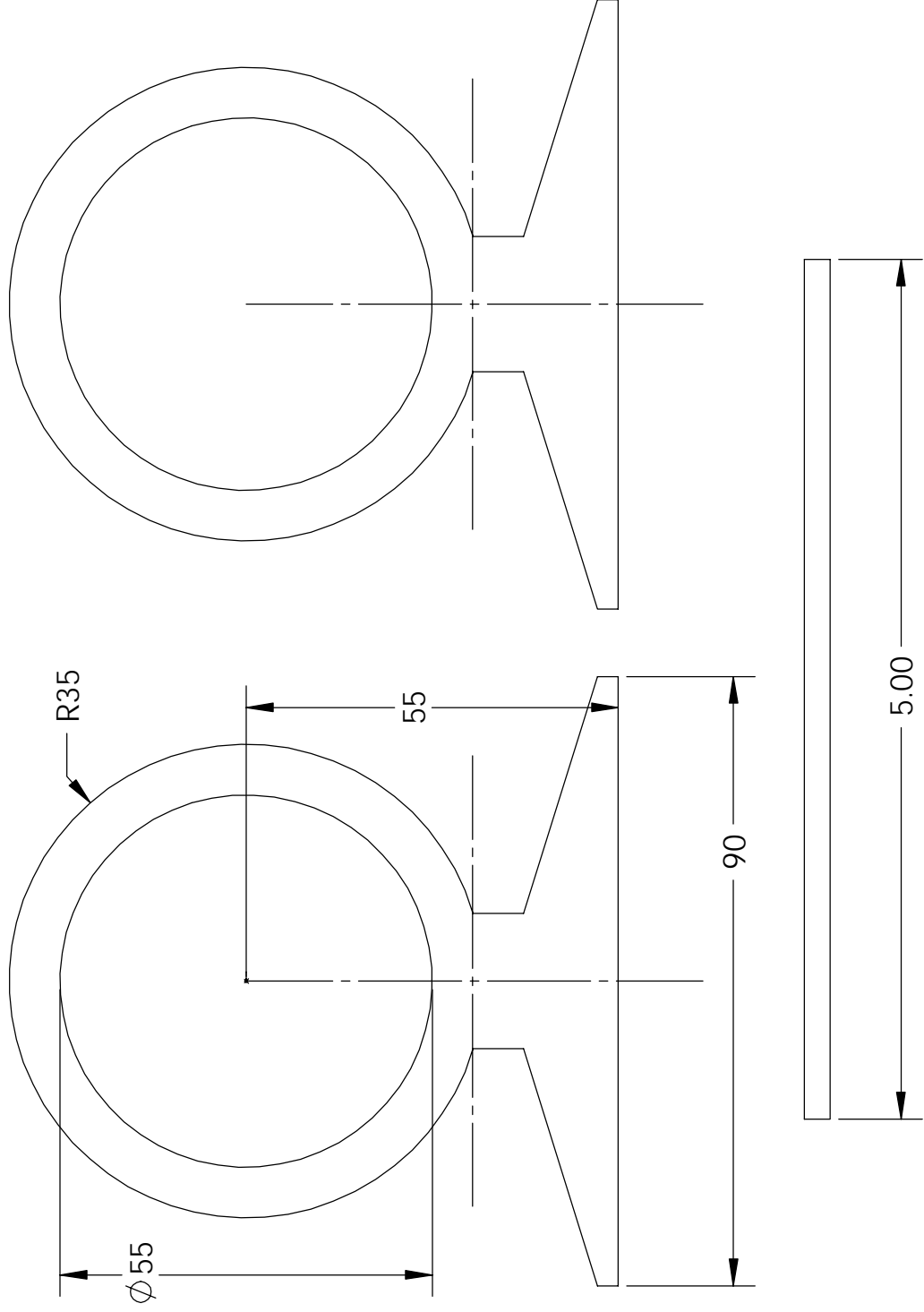

This is a 5 inch bar to check scale of printout.

Repeated Frequency Response Measurements
Modified Sennheiser HD 800 Left Channel

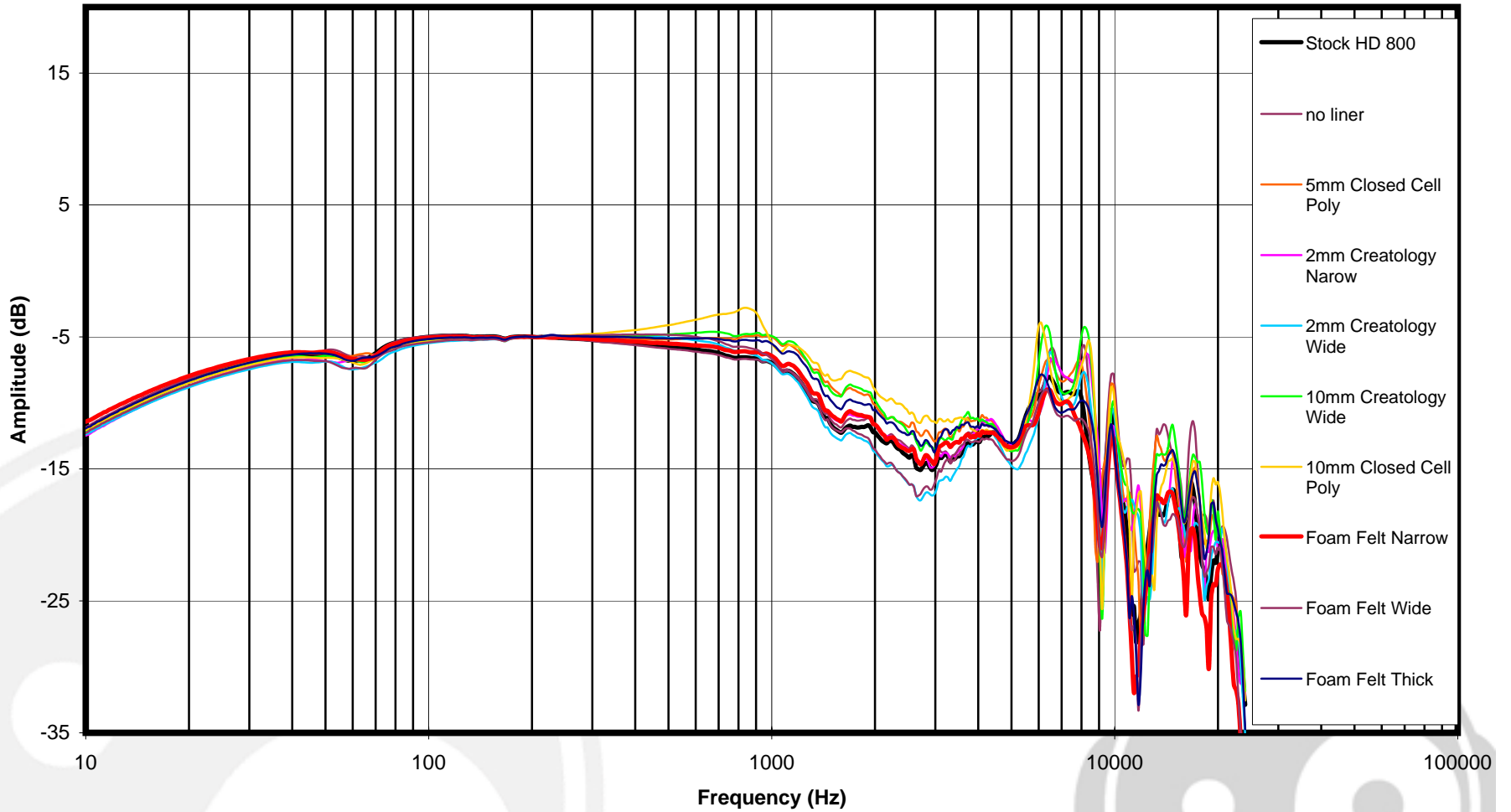

Repeated Frequency Response Measurements Modified Sennheiser HD 800 Right Channel

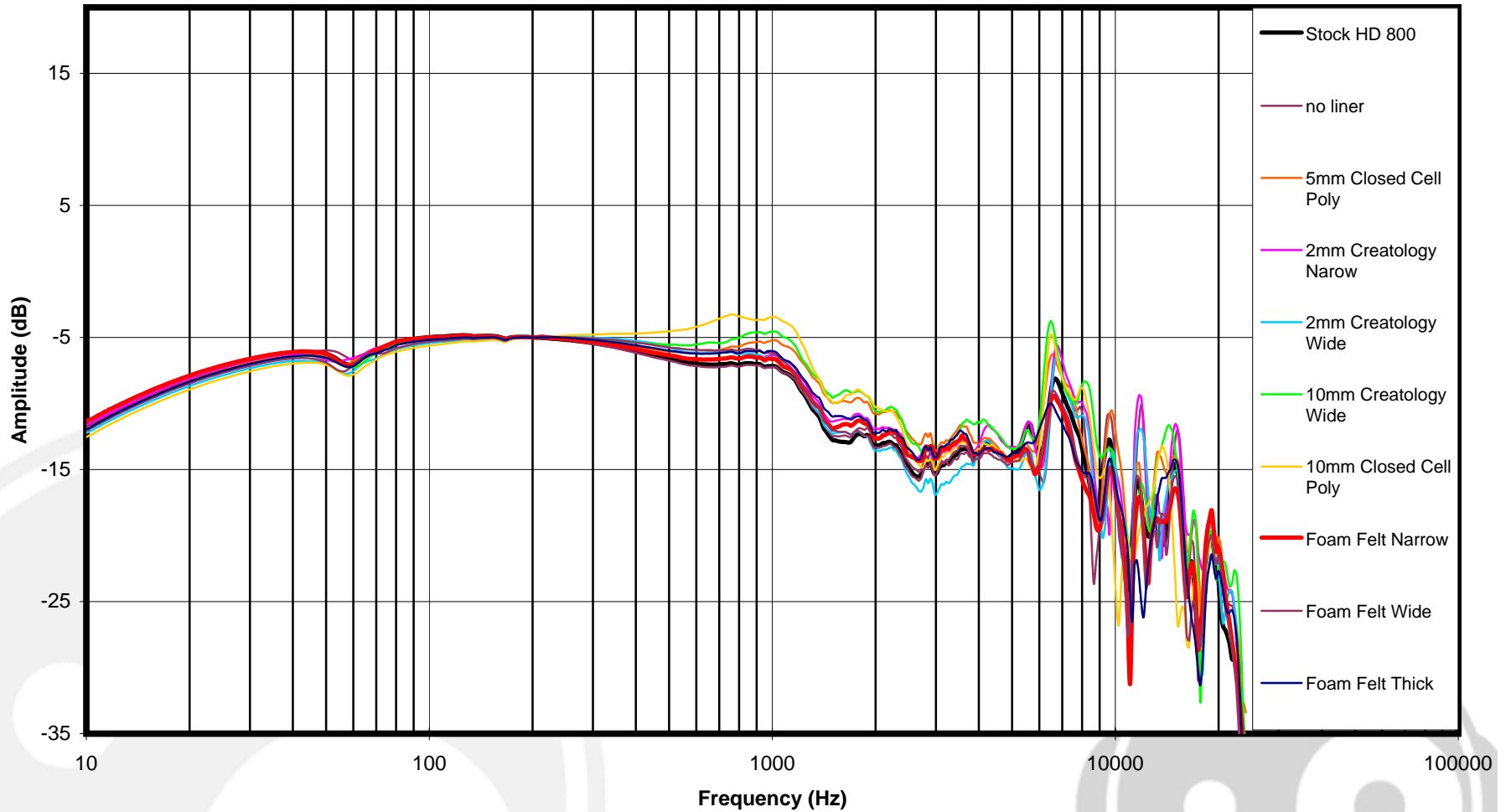

Frequency Response
 Top - Compensated and Averaged
 Bottom - Raw Data for Five Headphone Positions

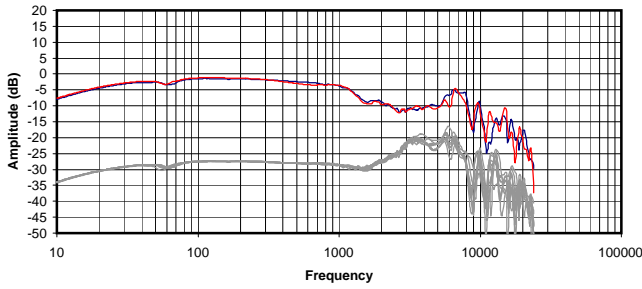

Isolation
 Attenuation of External Sound vs. Frequency

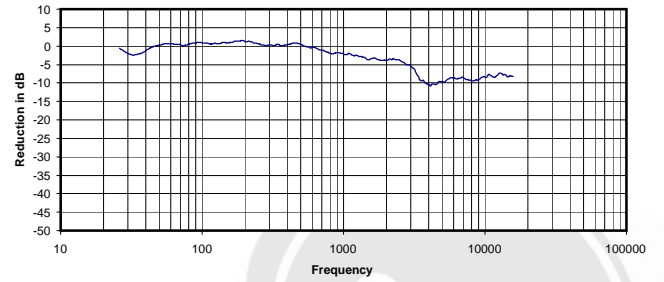

Electrical Impedance and Phase
 Measured with 600 Ohm output impedance.

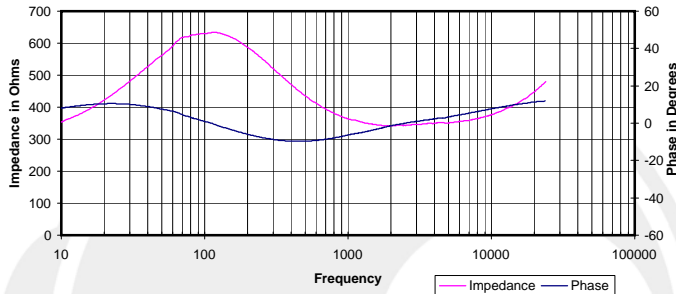

30 Hz Square Wave

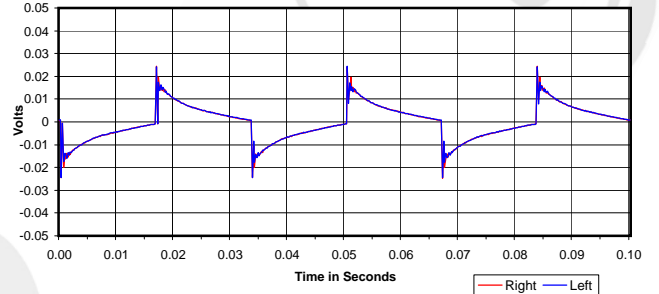

%THD+noise @ 90dB and 100dB

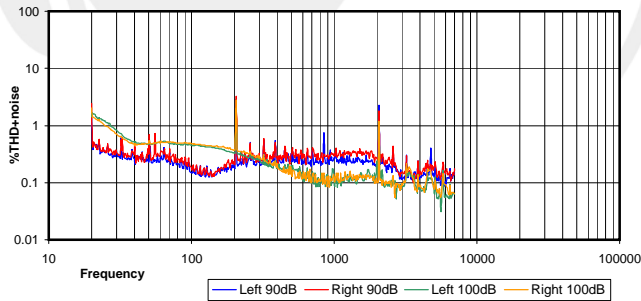

300 Hz Square Wave

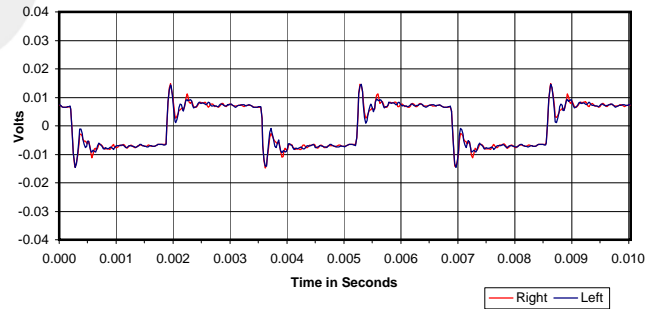

Impulse Response

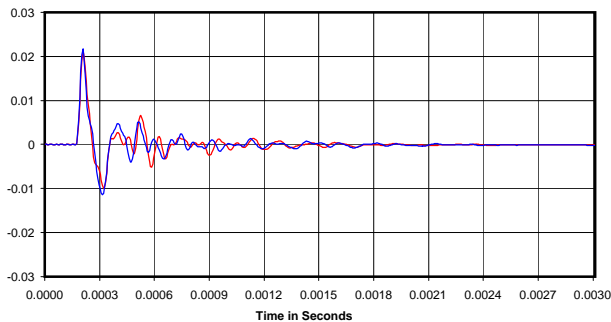

Volts RMS required to reach 90dB SPL:
 Impedance @ 1kHz:
 Power Needed for 90d BSPL
 Broadband Isolation in dB (100Hz to 10kHz):

0.254 Vrms
 364 Ohms
 0.18 mW
 -2 dB

Frequency Response
 Top - Compensated and Averaged
 Bottom - Raw Data for Five Headphone Positions

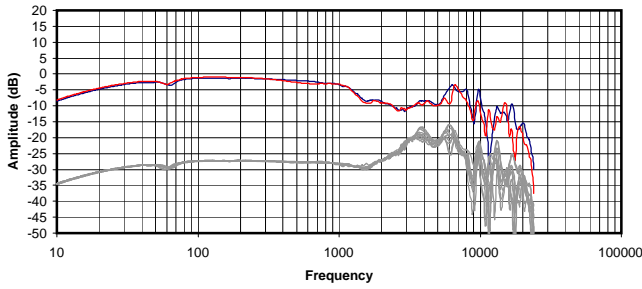

Isolation
 Attenuation of External Sound vs. Frequency

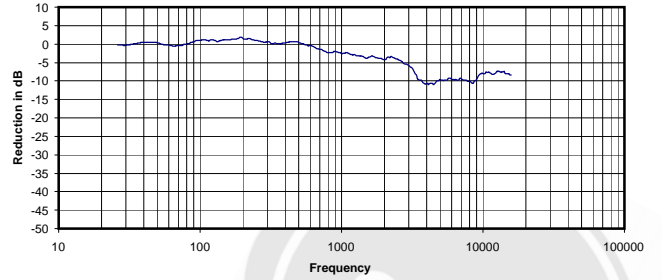

Electrical Impedance and Phase
 Measured with 600 Ohm output impedance.

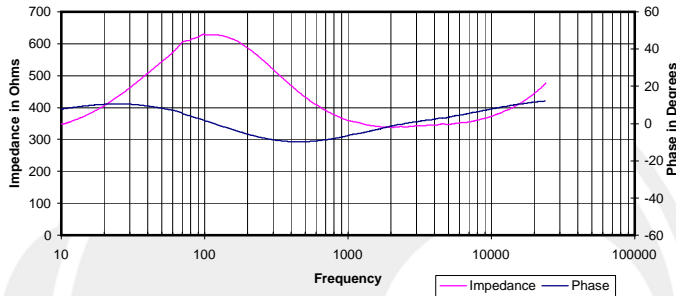

30 Hz Square Wave

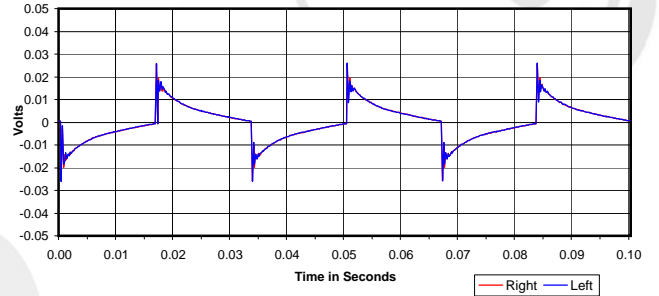

%THD+noise @ 90dB and 100dB

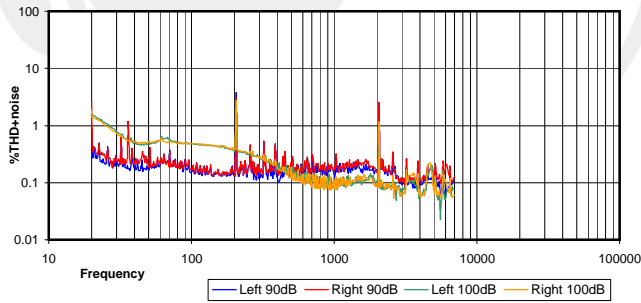

300 Hz Square Wave

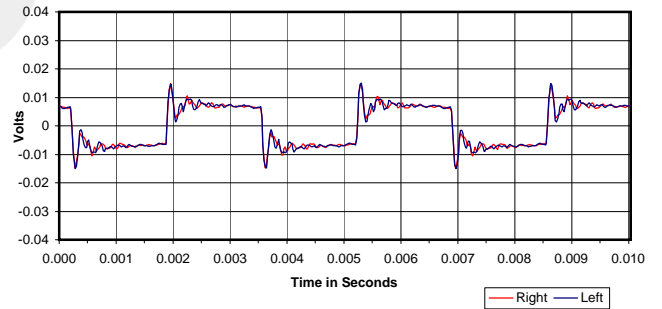

Impulse Response

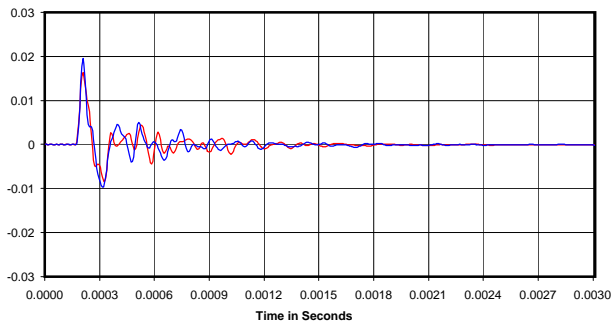

Volts RMS required to reach 90dB SPL:
 Impedance @ 1kHz:
 Power Needed for 90d BSPL
 Broadband Isolation in dB (100Hz to 10kHz):

0.245 Vrms
 360 Ohms
 0.17 mW
 -2 dB

Frequency Response
 Top - Compensated and Averaged
 Bottom - Raw Data for Five Headphone Positions

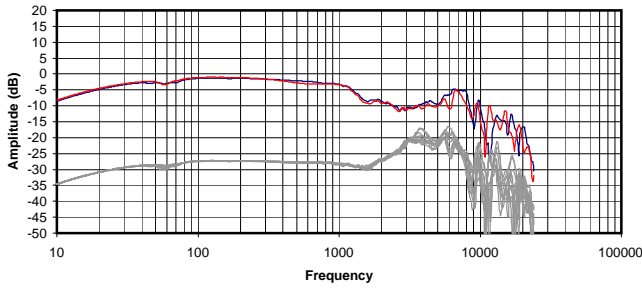

Isolation
 Attenuation of External Sound vs. Frequency

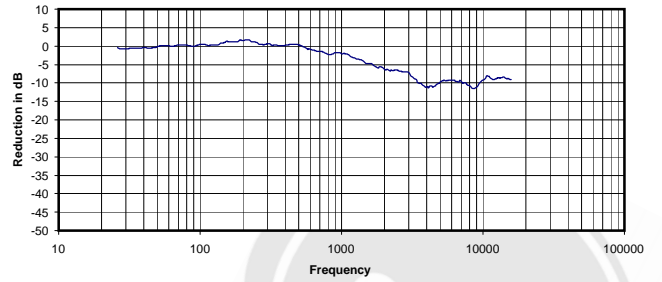

Electrical Impedance and Phase
 Measured with 600 Ohm output impedance.

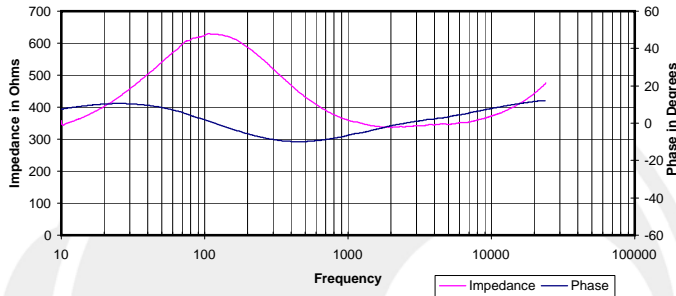

30 Hz Square Wave

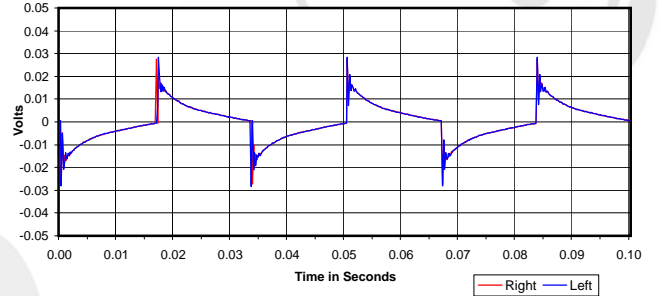

%THD+noise @ 90dB and 100dB

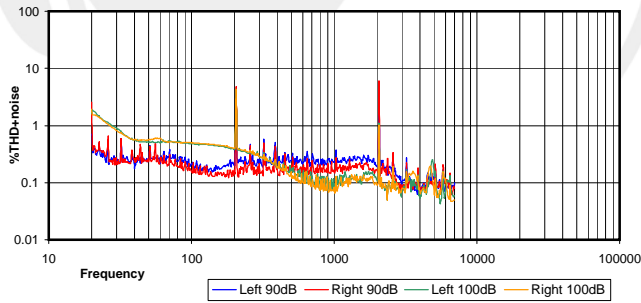

300 Hz Square Wave

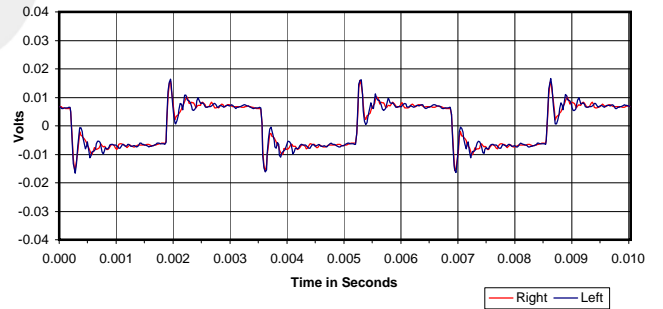

Impulse Response

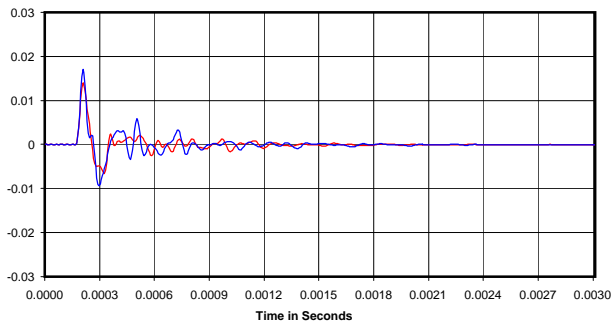

Volts RMS required to reach 90dB SPL:
 Impedance @ 1kHz:
 Power Needed for 90d BSPL
 Broadband Isolation in dB (100Hz to 10kHz):

0.242 Vrms
 359 Ohms
 0.16 mW
 -3 dB



Frequency Response
 Top - Compensated and Averaged
 Bottom - Raw Data for Five Headphone Positions

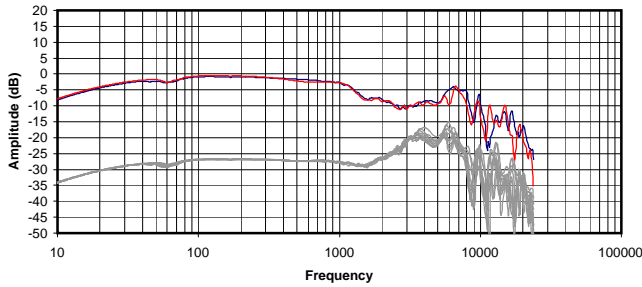

Isolation
 Attenuation of External Sound vs. Frequency

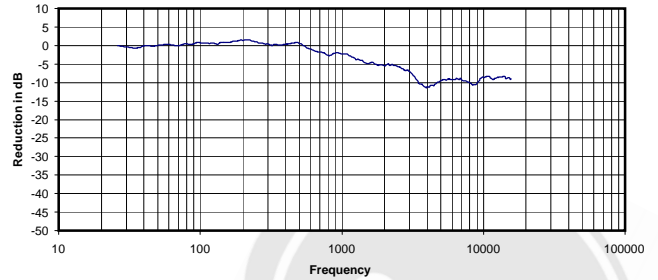

Electrical Impedance and Phase
 Measured with 600 Ohm output impedance.

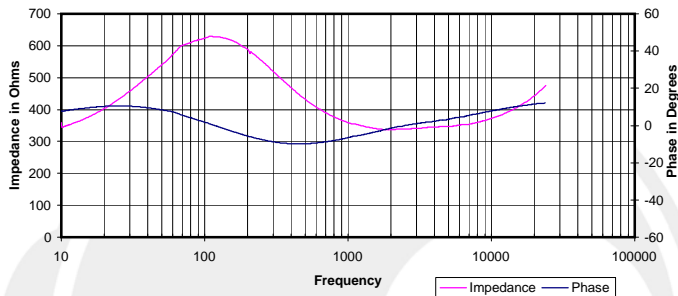

30 Hz Square Wave

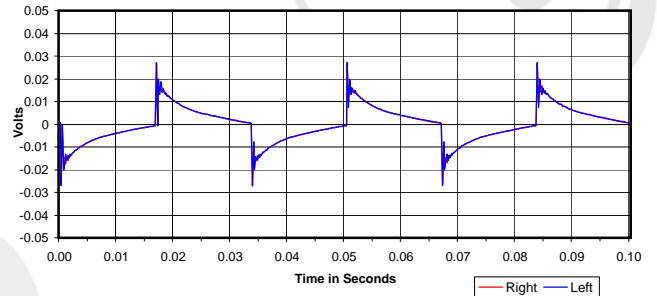

%THD+noise @ 90dB and 100dB

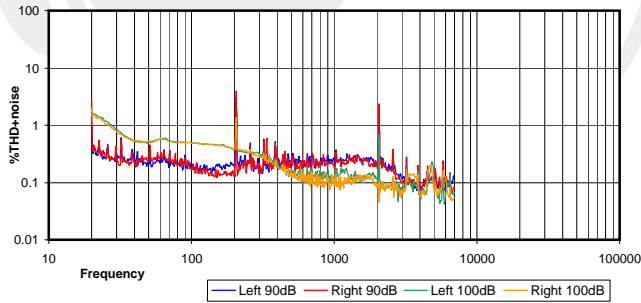

300 Hz Square Wave

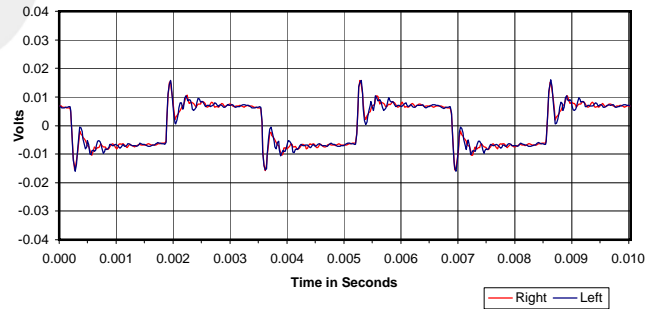

Impulse Response

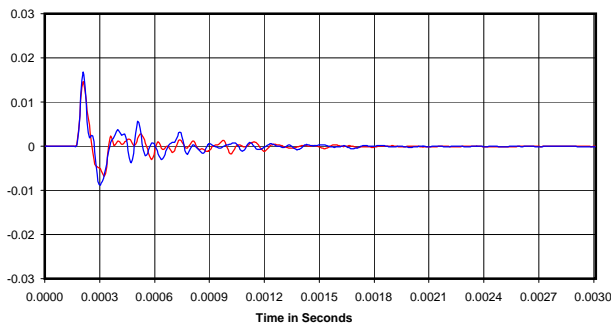

Volts RMS required to reach 90dB SPL:
 Impedance @ 1kHz:
 Power Needed for 90d BSPL
 Broadband Isolation in dB (100Hz to 10kHz):

0.245 Vrms
 359 Ohms
 0.17 mW
 -3 dBr

Frequency Response
 Top - Compensated and Averaged
 Bottom - Raw Data for Five Headphone Positions

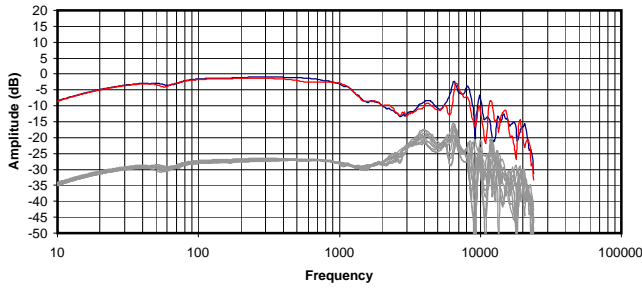

Isolation
 Attenuation of External Sound vs. Frequency

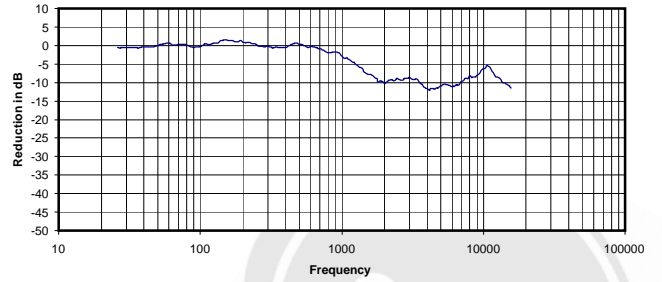

Electrical Impedance and Phase
 Measured with 600 Ohm output impedance.

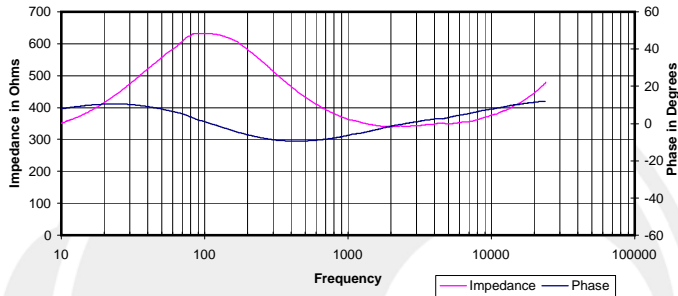

30 Hz Square Wave

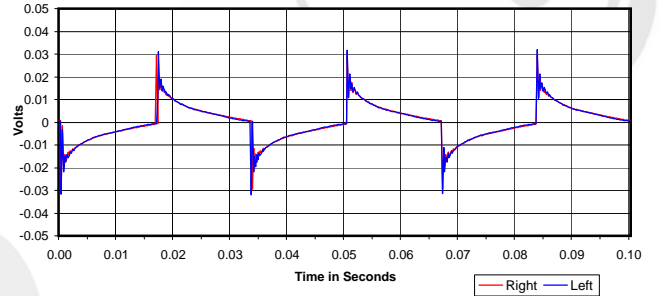

%THD+noise @ 90dB and 100dB

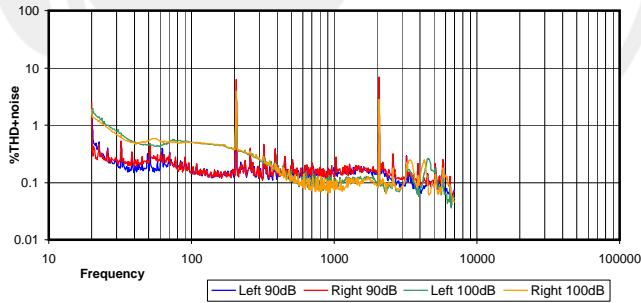

300 Hz Square Wave

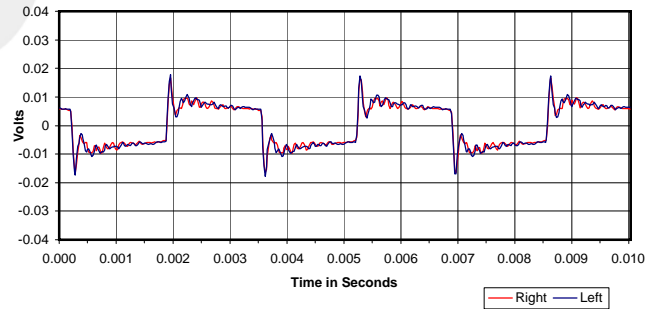

Impulse Response

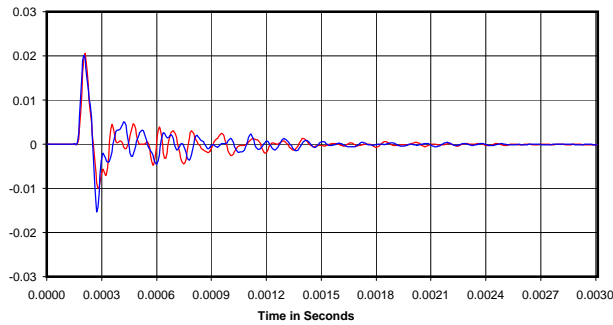

Volts RMS required to reach 90dB SPL:
 Impedance @ 1kHz:
 Power Needed for 90d BSPL
 Broadband Isolation in dB (100Hz to 10kHz):

0.197 Vrms
 364 Ohms
 0.11 mW
 -4 dB



Frequency Response
Top - Compensated and Averaged
Bottom - Raw Data for Five Headphone Positions

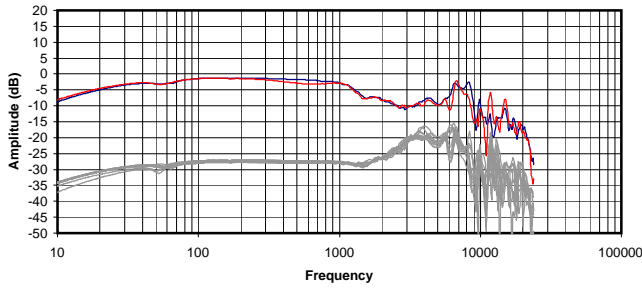

Isolation
Attenuation of External Sound vs. Frequency

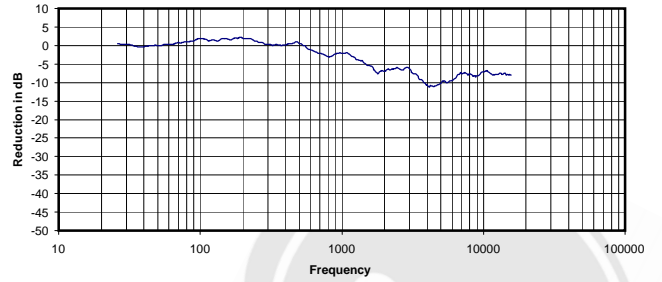

Electrical Impedance and Phase
Measured with 600 Ohm output impedance.

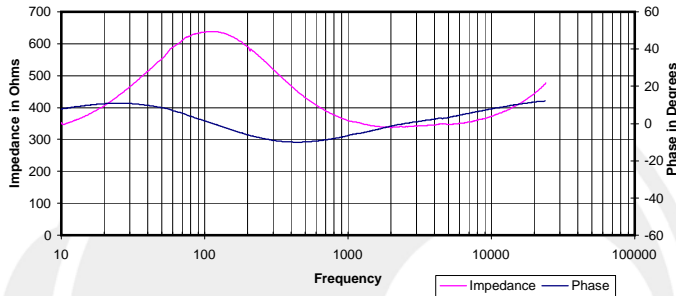

30 Hz Square Wave

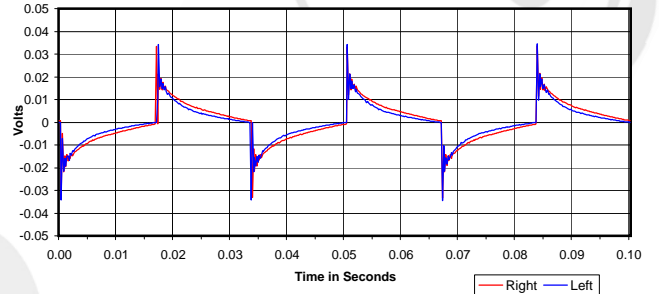

%THD+noise @ 90dB and 100dB

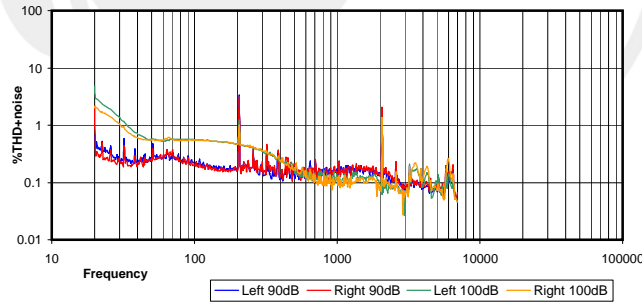

300 Hz Square Wave

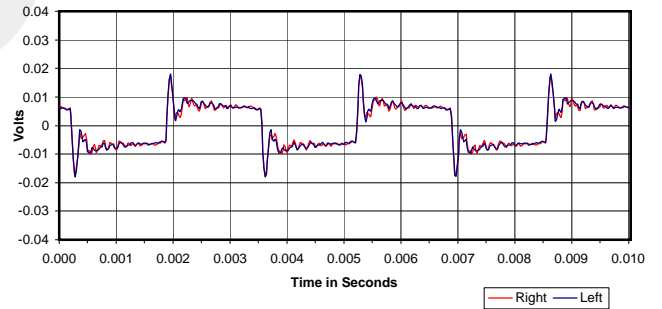

Impulse Response

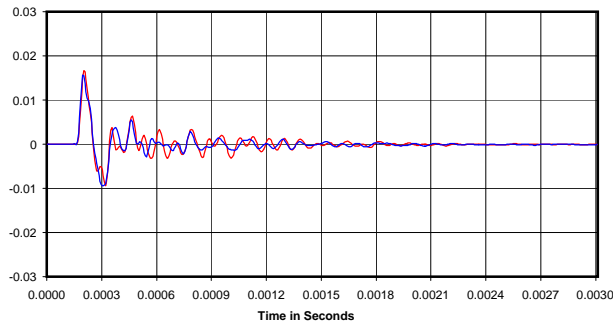

Volts RMS required to reach 90dB SPL:
Impedance @ 1kHz:
Power Needed for 90d BSPL
Broadband Isolation in dB (100Hz to 10kHz):

0.225 Vrms
360 Ohms
0.14 mW
-3 dBr



Frequency Response
Top - Compensated and Averaged
Bottom - Raw Data for Five Headphone Positions

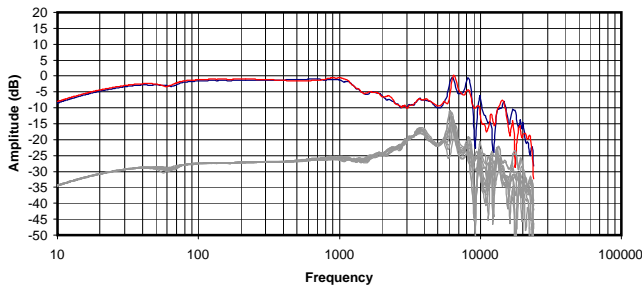

Isolation
Attenuation of External Sound vs. Frequency

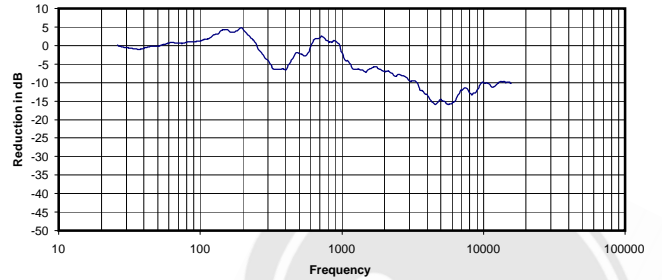

Electrical Impedance and Phase
Measured with 600 Ohm output impedance.

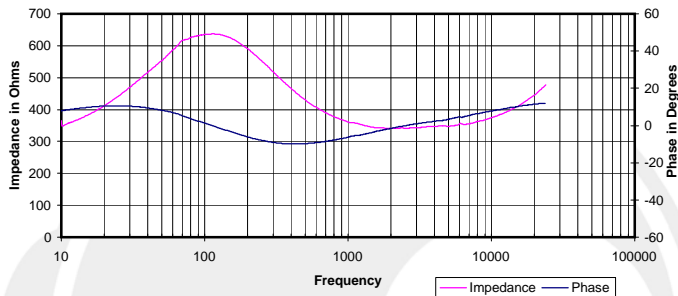

30 Hz Square Wave

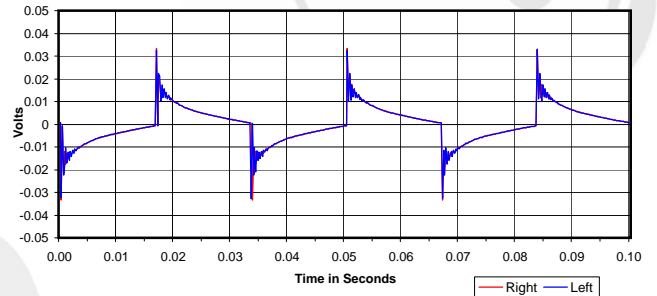

%THD+noise @ 90dB and 100dB

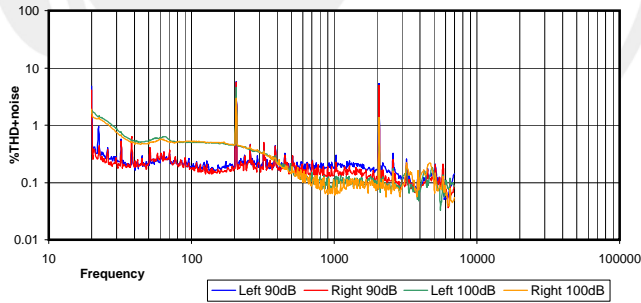

300 Hz Square Wave

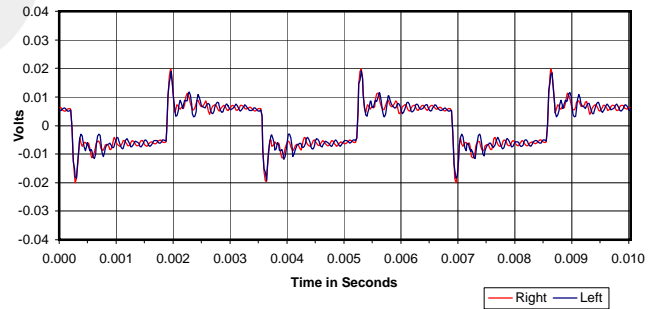

Impulse Response

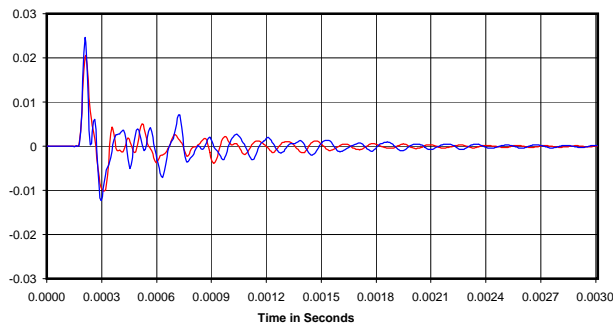

Volts RMS required to reach 90dB SPL:
Impedance @ 1kHz:
Power Needed for 90d BSPL
Broadband Isolation in dB (100Hz to 10kHz):

0.192 Vrms
362 Ohms
0.10 mW
-4 dBr



Frequency Response
 Top - Compensated and Averaged
 Bottom - Raw Data for Five Headphone Positions

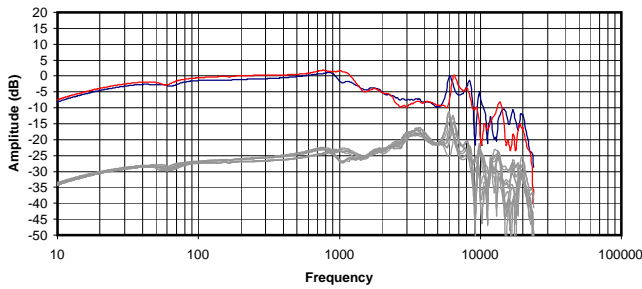

Isolation
 Attenuation of External Sound vs. Frequency

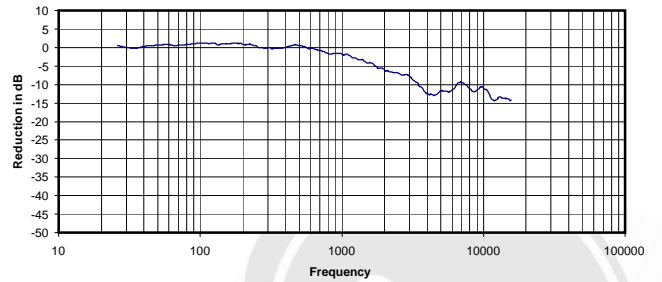

Electrical Impedance and Phase
 Measured with 600 Ohm output impedance.

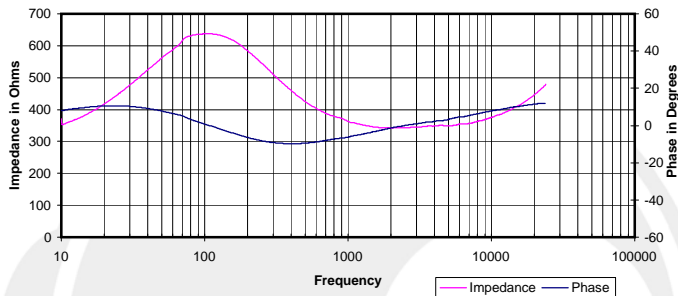

30 Hz Square Wave

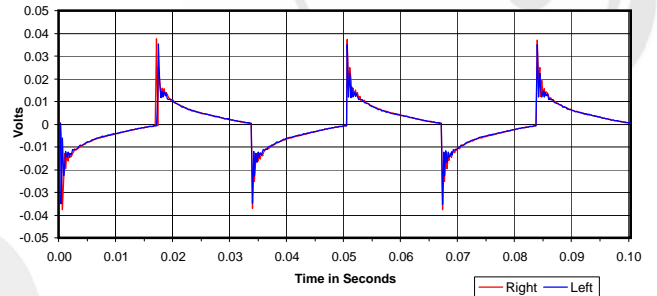

%THD+noise @ 90dB and 100dB

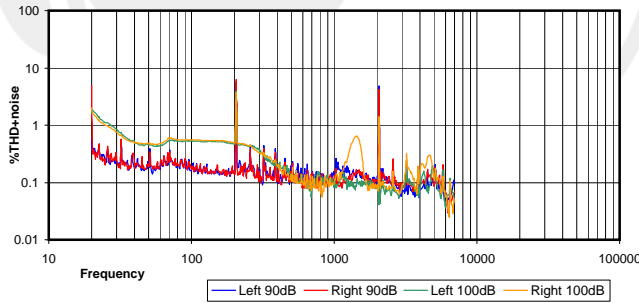

300 Hz Square Wave

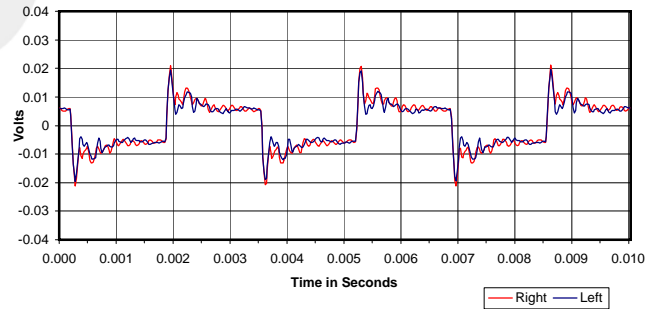

Impulse Response

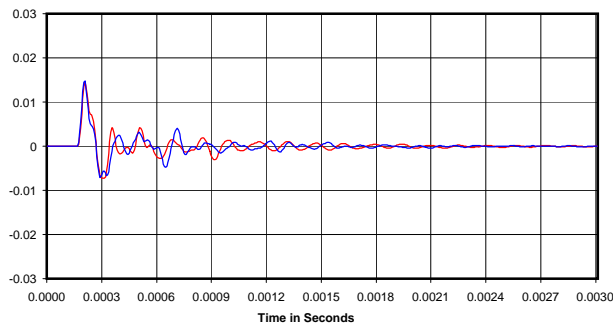

Volts RMS required to reach 90dB SPL:
 Impedance @ 1kHz:
 Power Needed for 90d BSPL
 Broadband Isolation in dB (100Hz to 10kHz):

0.195 Vrms
 364 Ohms
 0.10 mW
 -3 dBr



Frequency Response
 Top - Compensated and Averaged
 Bottom - Raw Data for Five Headphone Positions

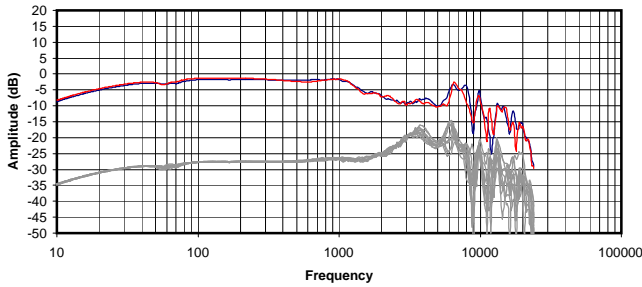

Isolation
 Attenuation of External Sound vs. Frequency

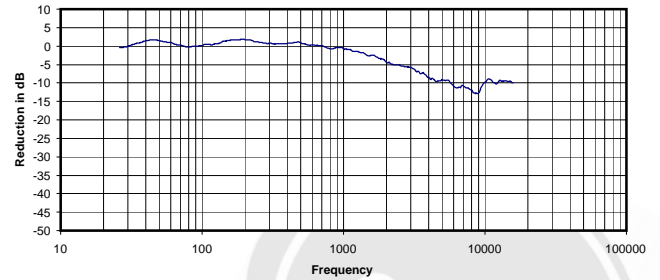

Electrical Impedance and Phase
 Measured with 600 Ohm output impedance.

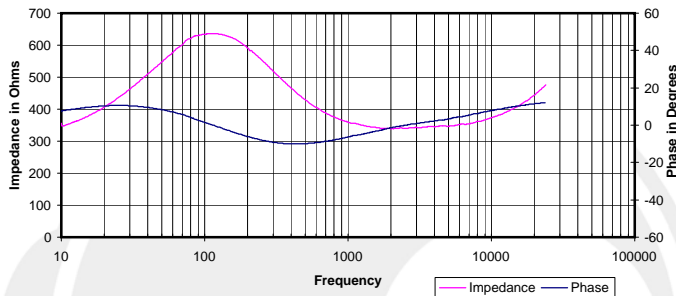

30 Hz Square Wave

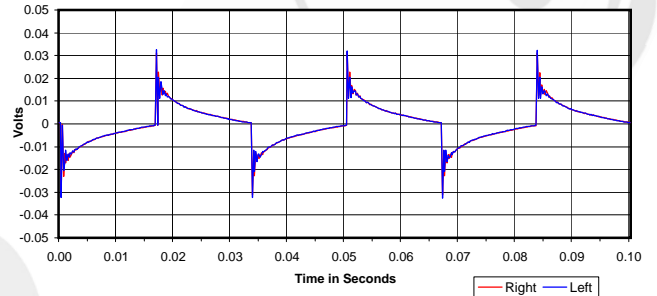

%THD+noise @ 90dB and 100dB

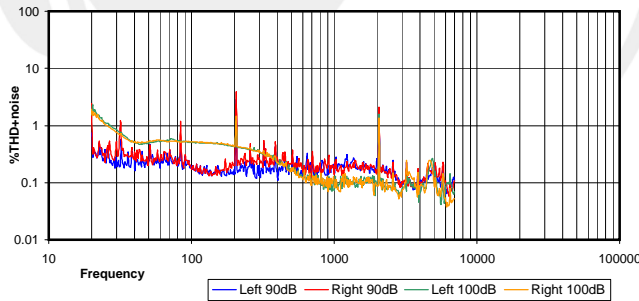

300 Hz Square Wave

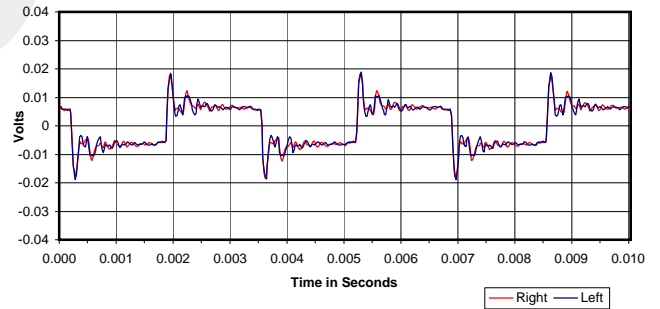

Impulse Response

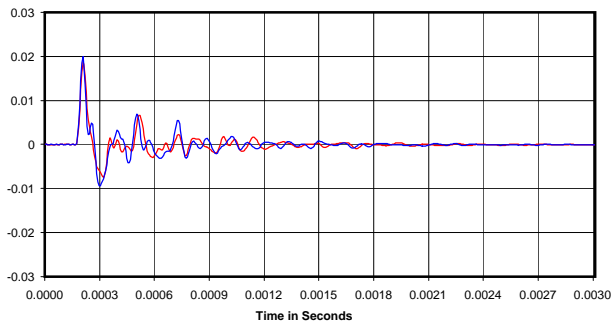

Volts RMS required to reach 90dB SPL:
 Impedance @ 1kHz:
 Power Needed for 90d BSPL
 Broadband Isolation in dB (100Hz to 10kHz):

0.199 Vrms
 359 Ohms
 0.11 mW
 -2 dB



Frequency Response
 Top - Compensated and Averaged
 Bottom - Raw Data for Five Headphone Positions

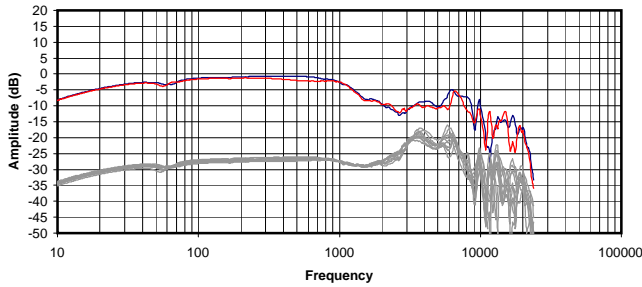

Isolation
 Attenuation of External Sound vs. Frequency

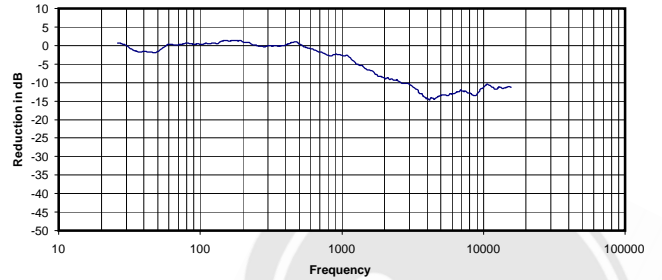

Electrical Impedance and Phase
 Measured with 600 Ohm output impedance.

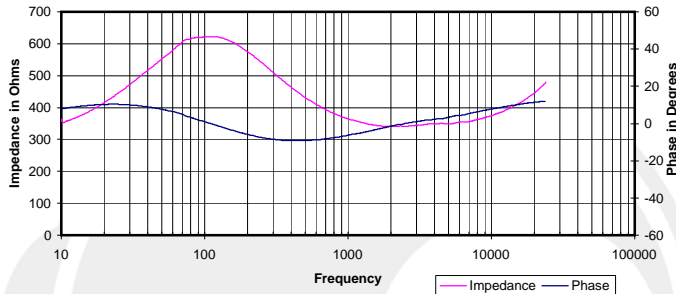

30 Hz Square Wave

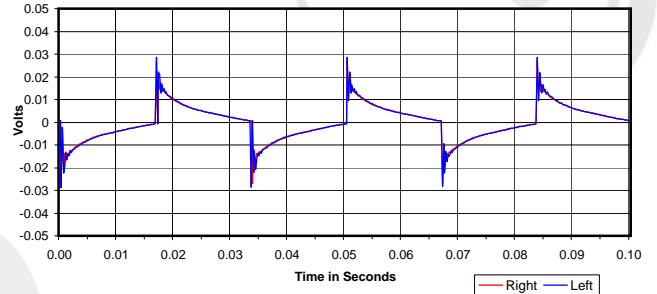

%THD+noise @ 90dB and 100dB

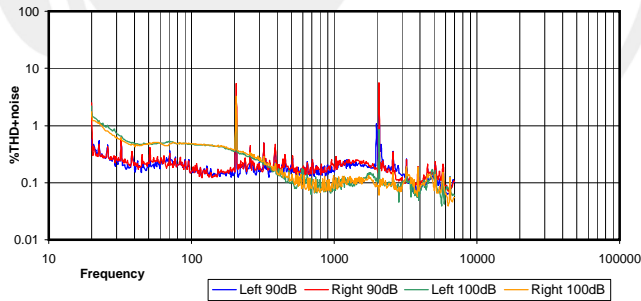

300 Hz Square Wave

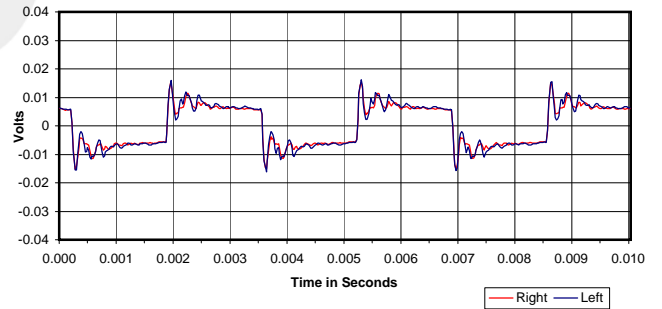

Impulse Response

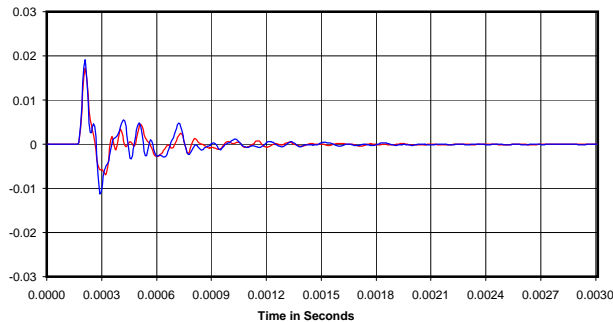

Volts RMS required to reach 90dB SPL:
 Impedance @ 1kHz:
 Power Needed for 90d BSPL
 Broadband Isolation in dB (100Hz to 10kHz):

0.192 Vrms
 364 Ohms
 0.10 mW
 -4 dBr



Frequency Response
 Top - Compensated and Averaged
 Bottom - Raw Data for Five Headphone Positions

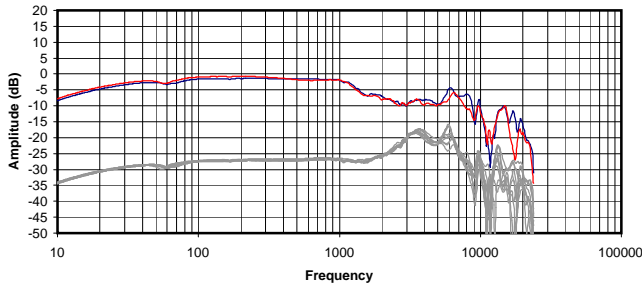

Isolation
 Attenuation of External Sound vs. Frequency

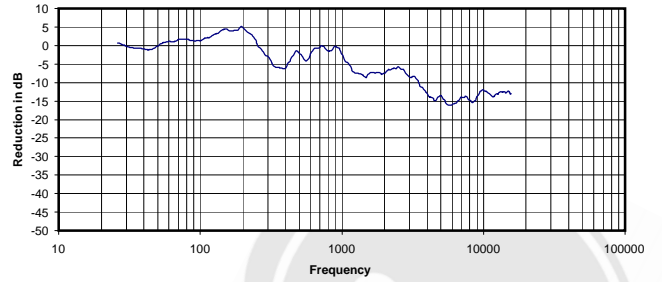

Electrical Impedance and Phase
 Measured with 600 Ohm output impedance.

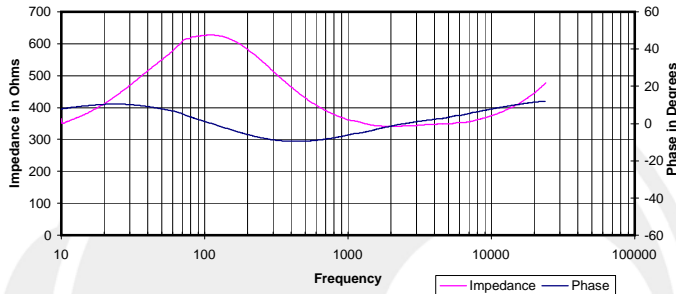

30 Hz Square Wave

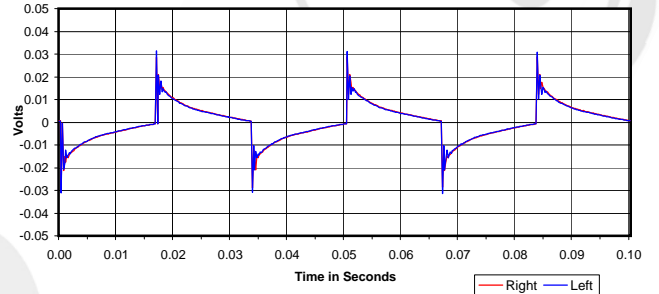

%THD+noise @ 90dB and 100dB

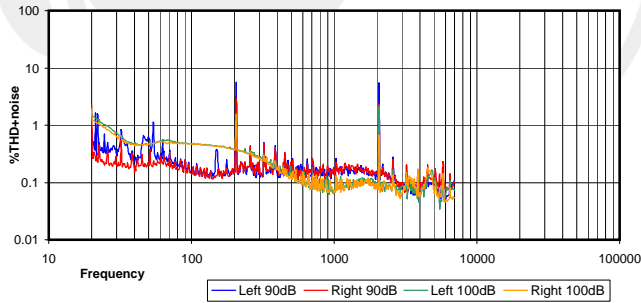

300 Hz Square Wave

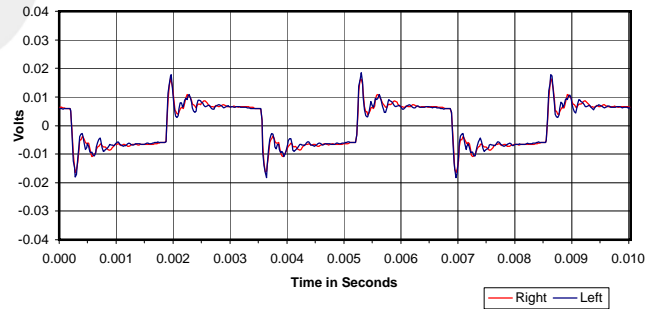

Impulse Response

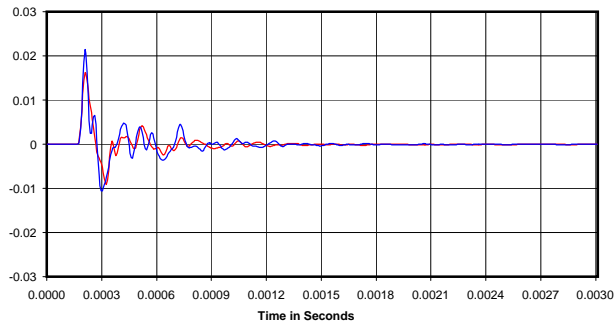

Volts RMS required to reach 90dB SPL:
 Impedance @ 1kHz:
 Power Needed for 90d BSPL
 Broadband Isolation in dB (100Hz to 10kHz):

0.194 Vrms
 362 Ohms
 0.10 mW
 -4 dBr



Frequency Response
 Top - Compensated and Averaged
 Bottom - Raw Data for Five Headphone Positions

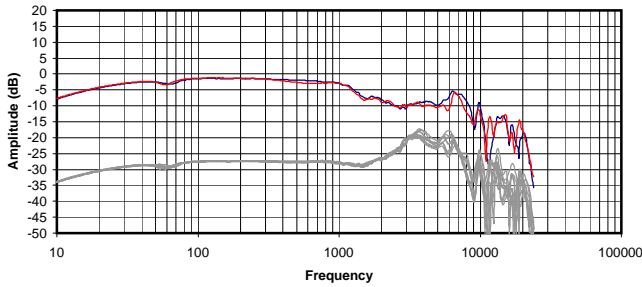

Isolation
 Attenuation of External Sound vs. Frequency

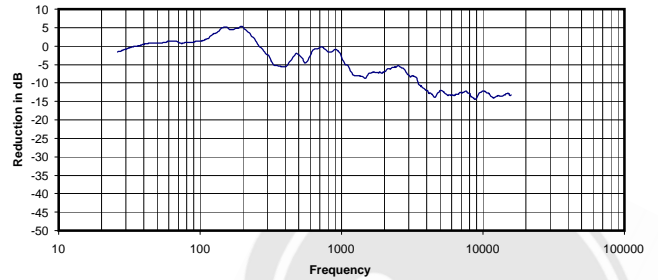

Electrical Impedance and Phase
 Measured with 600 Ohm output impedance.

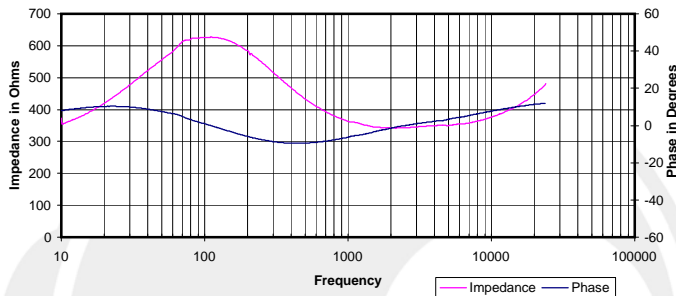

30 Hz Square Wave

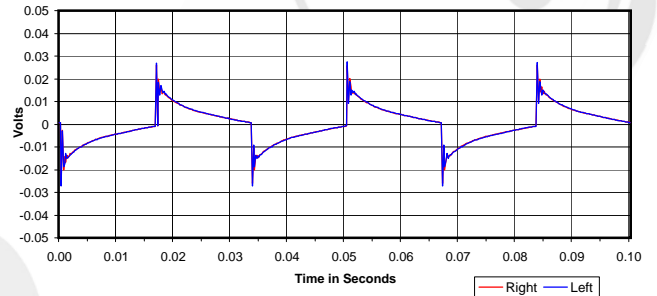

%THD+noise @ 90dB and 100dB

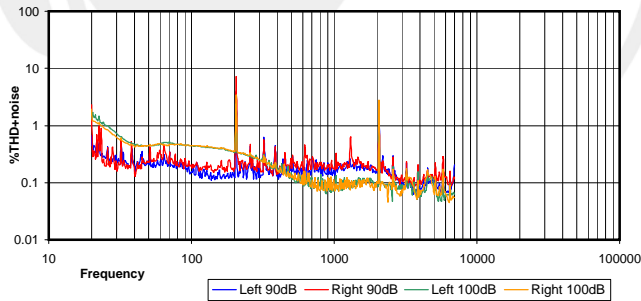

300 Hz Square Wave

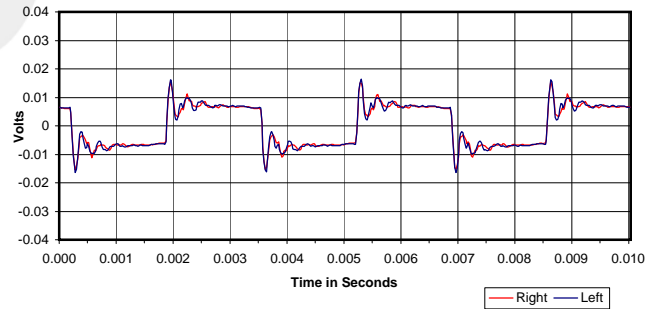

Impulse Response

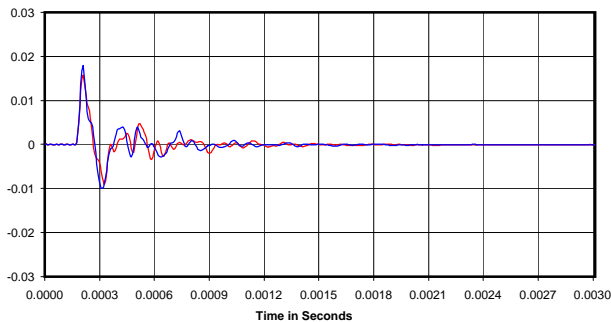

Volts RMS required to reach 90dB SPL:
 Impedance @ 1kHz:
 Power Needed for 90d BSPL
 Broadband Isolation in dB (100Hz to 10kHz):

0.217 Vrms
 364 Ohms
 0.13 mW
 -4 dBr

